

MIG100Q6CMB1X (1200V/100A 6in1)

High Power Switching Applications
 Motor Control Applications

- Integrates inverter power circuits and control circuits (IGBT drive units, protection units for short-circuit current, over current, under voltage and over temperature) in one package.
- The electrodes are isolated from case.
- $V_{CE(sat)} = 2.4\text{ V (typ.)}$
- UL recognized File No. E87989
- Weight: 385 g (typ.)

Equivalent Circuit

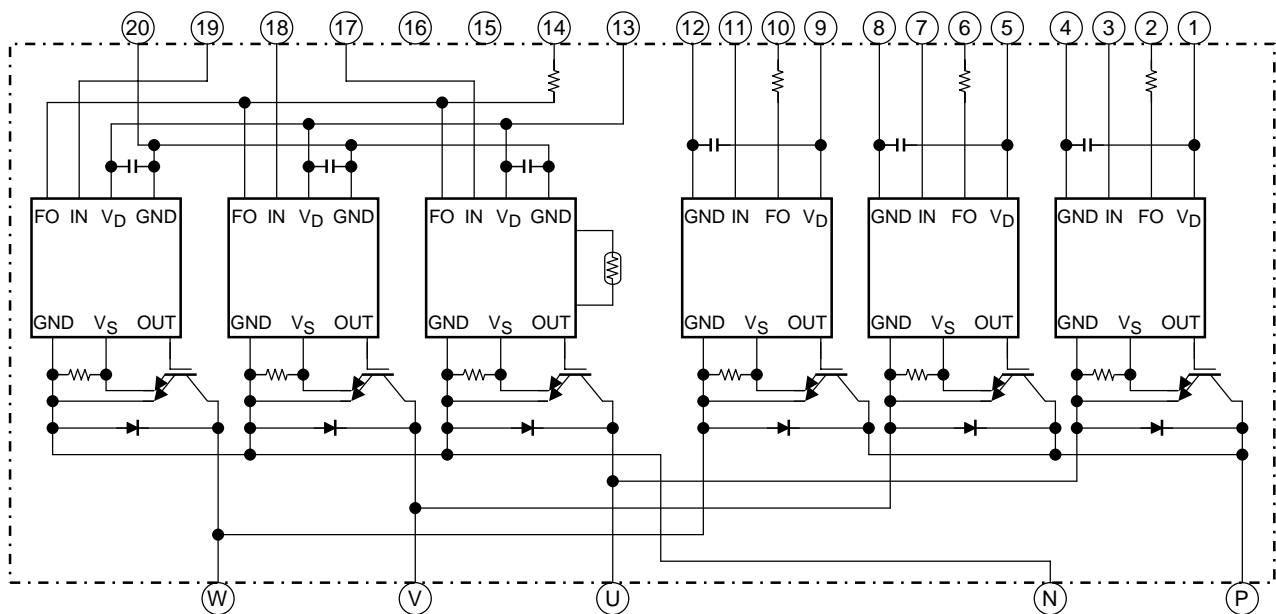

1. V_D (U)	2. FO (U)	3. IN (U)	4. GND (U)	5. V_D (V)	6. FO (V)	7. IN (V)
8. GND (V)	9. V_D (W)	10. FO (W)	11. IN (W)	12. GND (W)	13. V_D (L)	14. FO (L)
15. Open	16. Open	17. IN (X)	18. IN (Y)	19. IN (Z)	20. GND (L)	

Package Dimensions: TOSHIBA 2-123A1A

Unit: mm

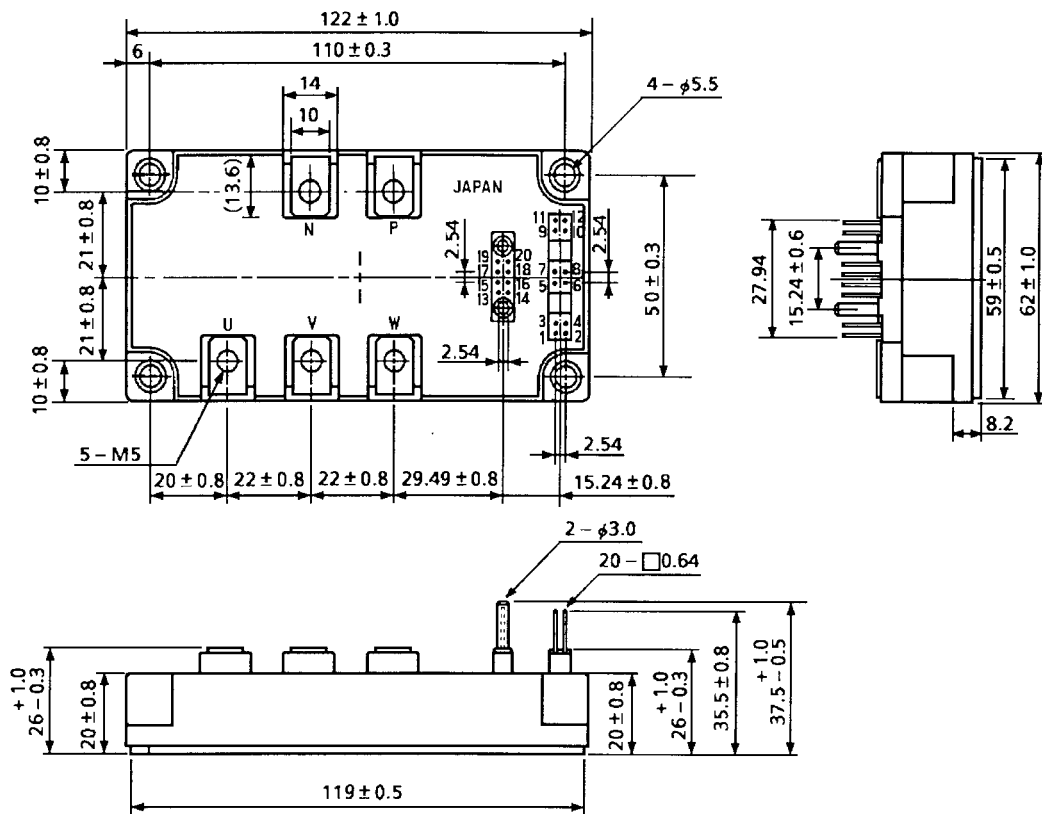

- | | | | | | |
|---------------|-------------|--------------|------------|--------------|-------------|
| 1. V_D (U) | 2. FO (U) | 3. IN (U) | 4. GND (U) | 5. V_D (V) | 6. FO (V) |
| 7. IN (V) | 8. GND (V) | 9. V_D (W) | 10. FO (W) | 11. IN (W) | 12. GND (W) |
| 13. V_D (L) | 14. FO (L) | 15. Open | 16. Open | 17. IN (X) | 18. IN (Y) |
| 19. IN (Z) | 20. GND (L) | | | | |

Signal Terminal Layout

Unit: mm

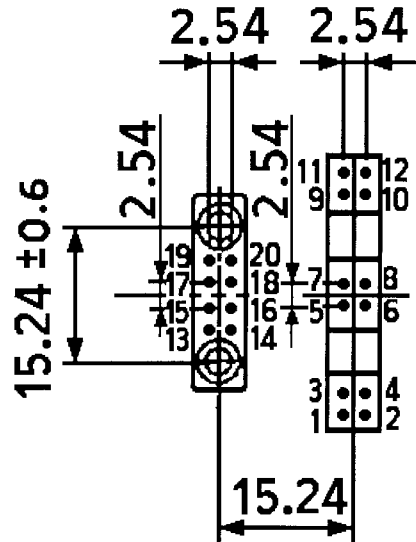

1. V _D (U)	2. FO (U)	3. IN (U)	4. GND (U)	5. V _D (V)	6. FO (V)
7. IN (V)	8. GND (V)	9. V _D (W)	10. FO (W)	11. IN (W)	12. GND (W)
13. V _D (L)	14. FO (L)	15. Open	16. Open	17. IN (X)	18. IN (Y)
19. IN (Z)	20. GND (L)				

Maximum Ratings ($T_j = 25^\circ\text{C}$)

Stage	Characteristic	Condition	Symbol	Ratings	Unit
Inverter	Supply voltage	P-N power terminal	V_{CC}	900	V
	Collector-emitter voltage	—	V_{CES}	1200	V
	Collector current	$T_c = 25^\circ\text{C}$, DC	I_C	100	A
	Forward current	$T_c = 25^\circ\text{C}$, DC	I_F	100	A
	Collector power dissipation	$T_c = 25^\circ\text{C}$	P_C	960	W
	Junction temperature	—	T_j	150	$^\circ\text{C}$
Control	Control supply voltage	V_D -GND terminal	V_D	20	V
	Input voltage	IN-GND terminal	V_{IN}	20	V
	Fault output voltage	FO-GND (L) terminal	V_{FO}	20	V
	Fault output current	FO sink current	I_{FO}	14	mA
Module	Operating temperature	—	T_c	-20~+100	$^\circ\text{C}$
	Storage temperature range	—	T_{stg}	-40~+125	$^\circ\text{C}$
	Isolation voltage	AC 1 minute	V_{ISO}	2500	V
	Screw torque (terminal/mounting)	M5	—	3	N·m

Electrical Characteristics

1. Inverter Stage

Characteristic	Symbol	Test Condition	Min	Typ.	Max	Unit	
Collector cut-off current	I_{CEX}	$V_{CE} = 1200\text{ V}$	$T_j = 25^\circ\text{C}$	—	—	1	mA
			$T_j = 125^\circ\text{C}$	—	—	10	
Collector-emitter saturation voltage	$V_{CE(sat)}$	$V_D = 15\text{ V}$, $I_C = 100\text{ A}$, $V_{IN} = 15\text{ V} \rightarrow 0\text{ V}$	$T_j = 25^\circ\text{C}$	—	2.4	2.8	V
			$T_j = 125^\circ\text{C}$	—	—	3.2	
Forward voltage	V_F	$I_F = 100\text{ A}$, $T_j = 25^\circ\text{C}$	—	2.2	2.6	V	
Switching time	t_{on}	$V_{CC} = 600\text{ V}$, $I_C = 100\text{ A}$, $V_D = 15\text{ V}$, $V_{IN} = 15\text{ V} \leftrightarrow 0\text{ V}$, $T_j = 25^\circ\text{C}$, Inductive load (Note 1)	—	3.0	4.0	μs	
	$t_c(\text{on})$		—	0.35	—		
	t_{rr}		—	0.3	—		
	t_{off}		—	1.5	2.5		
	$t_c(\text{off})$		—	0.3	—		

Note 1: Switching time test circuit and timing chart.

2. Control Stage ($T_j = 25^\circ\text{C}$)

Characteristic		Symbol	Test Condition	Min	Typ.	Max	Unit
Control circuit current	High side	I_D (H)	$V_D = 15\text{ V}$	—	13	17	mA
	Low side	I_D (L)		—	39	51	
Input-on signal voltage		V_{IN} (on)	$V_D = 15\text{ V}$	1.4	1.6	1.8	V
Input-off signal voltage		V_{IN} (off)	$V_D = 15\text{ V}$	2.2	2.5	2.8	V
Fault output current	Protection	I_{FO} (on)	$V_D = 15\text{ V}, T_j \leq 125^\circ\text{C}$	—	10	12	mA
	Normal	I_{FO} (off)		—	—	0.1	
Over current protection trip level		OC	$V_D = 15\text{ V}, T_j \leq 125^\circ\text{C}$	160	—	—	A
Short-circuit current protection trip level		SC	$V_D = 15\text{ V}, T_j \leq 125^\circ\text{C}$	160	—	—	A
Over current cut-off time		t_{off} (OC)	$V_D = 15\text{ V}$	—	5	—	μs
Over temperature protection	Trip level	OT	Case temperature	110	118	125	$^\circ\text{C}$
	Reset level	OTr		—	98	—	
Control supply under voltage protection	Trip level	UV	—	11.0	12.0	12.5	V
	Reset level	UVr		12.0	12.5	13.0	
Fault output pulse width		t_{FO}	$V_D = 15\text{ V}$	1	2	3	ms

3. Thermal Resistance ($T_c = 25^\circ\text{C}$)

Characteristic	Symbol	Test Condition	Min	Typ.	Max	Unit
Junction to case thermal resistance	R_{th} (j-c)	IGBT	—	—	0.130	$^\circ\text{C/W}$
		FWD	—	—	0.190	
Case to fin thermal resistance	R_{th} (c-f)	Compound is applied	—	0.013	—	$^\circ\text{C/W}$

Switching Time Test Circuit

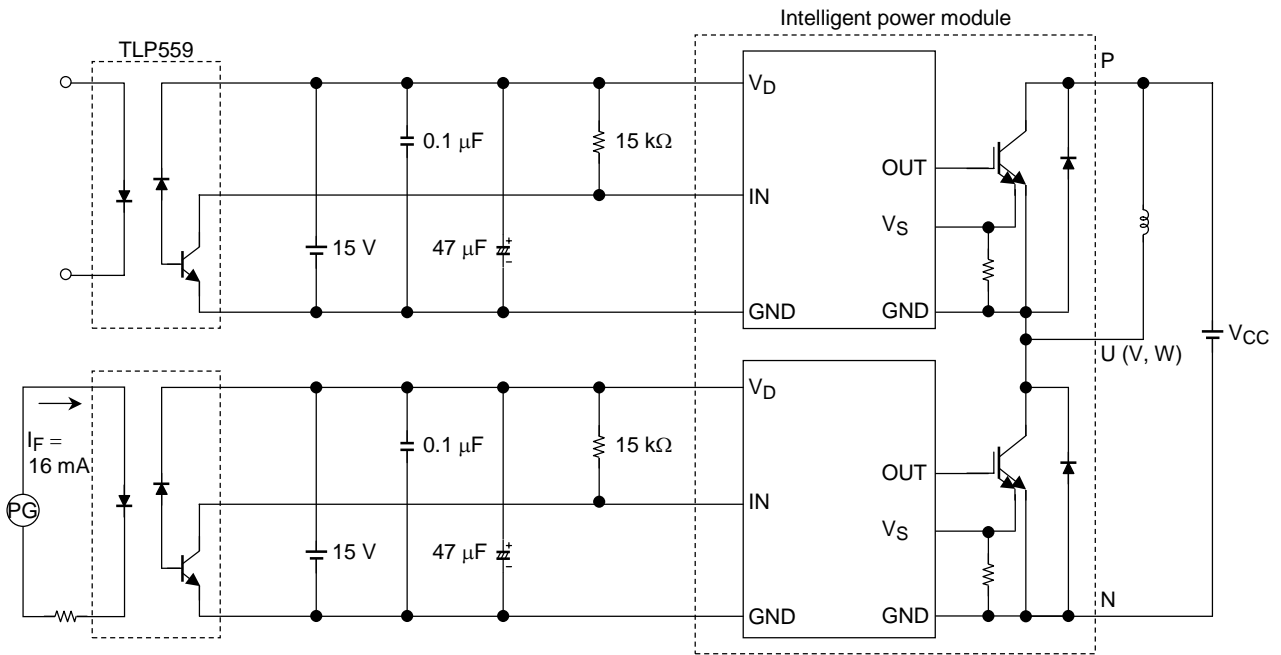

Timing Chart

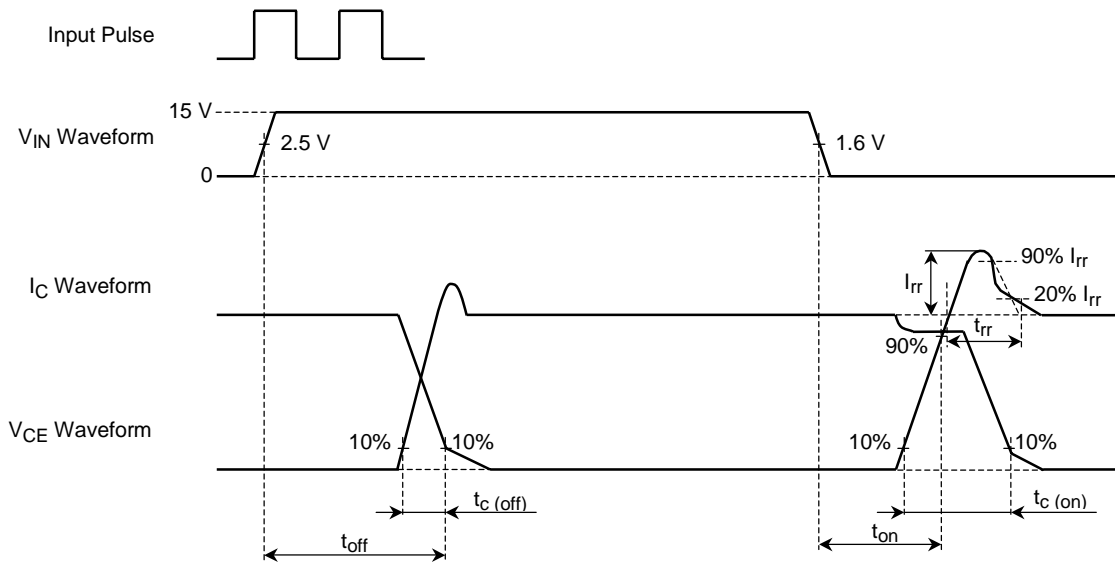

4. Recommended conditions for application

Characteristic	Symbol	Test Condition	Min	Typ.	Max	Unit
Supply voltage	V _{CC}	P-N Power terminal	—	600	800	V
Control supply voltage	V _D	V _D -GND Signal terminal	13.5	15	16.5	V
Carrier frequency	f _c	PWM Control	—	—	20	kHz
Dead time	t _{dead}	Switching time test circuit (see page.6) (Note 2)	4	—	—	μs

Note 2: The table lists Dead time requirements for the module input, excluding photocoupler delays. When specifying dead time requirements for the photocoupler input, please add photocoupler delays to the dead time given above.

Dead Time Timing Chart

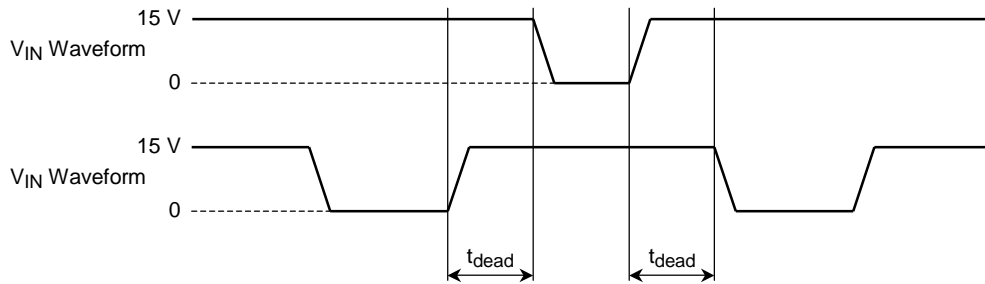

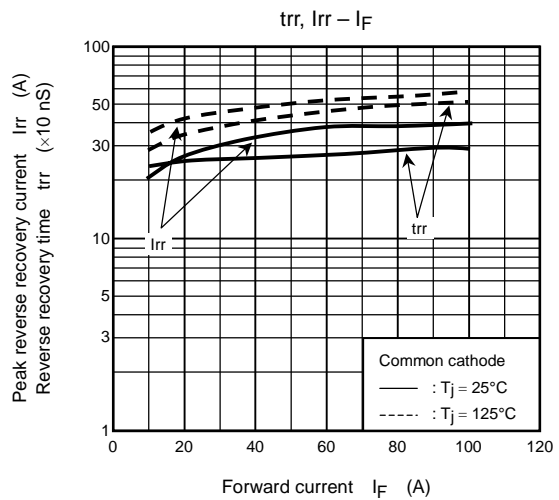
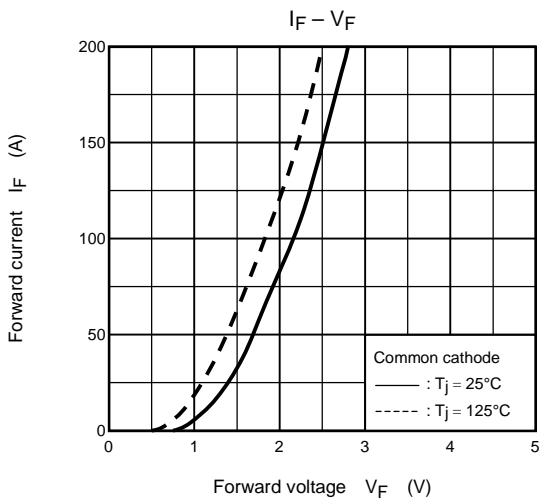
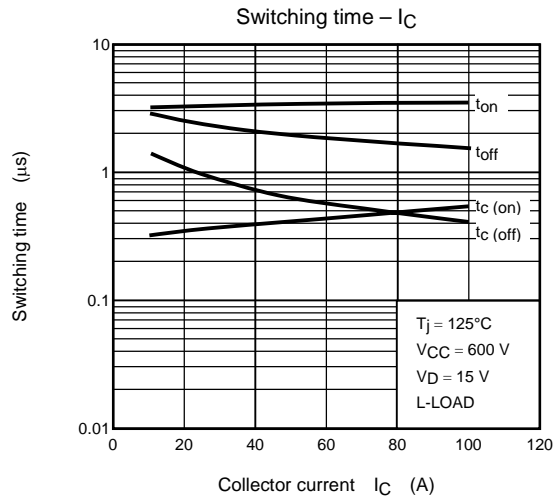
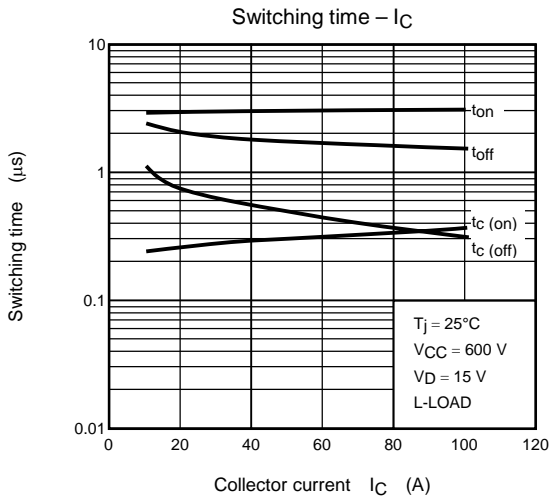
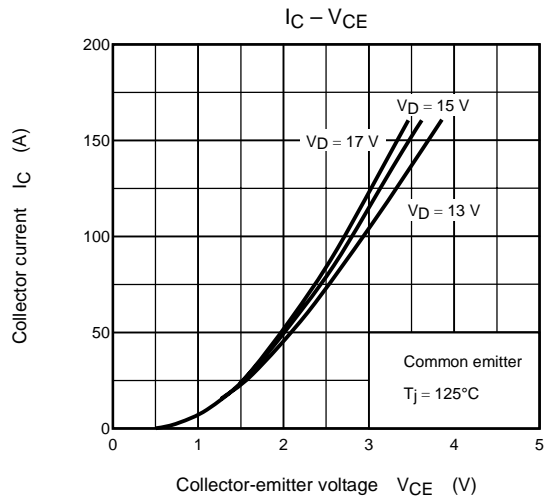
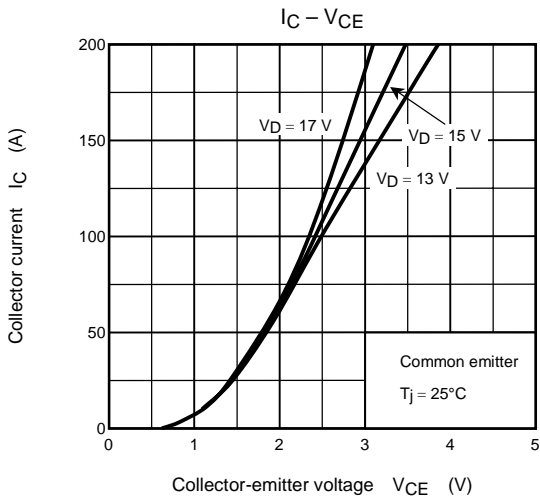

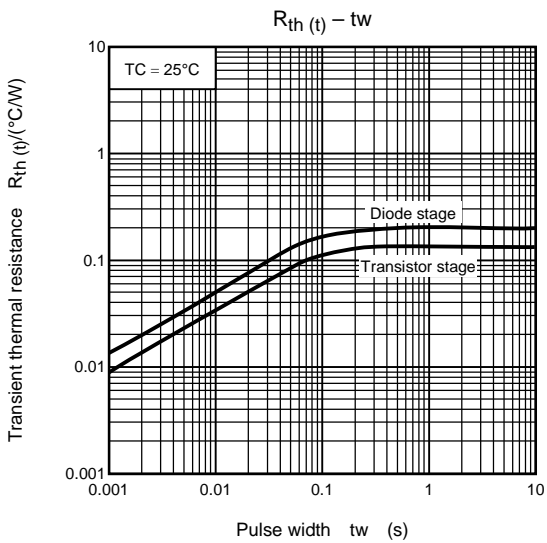
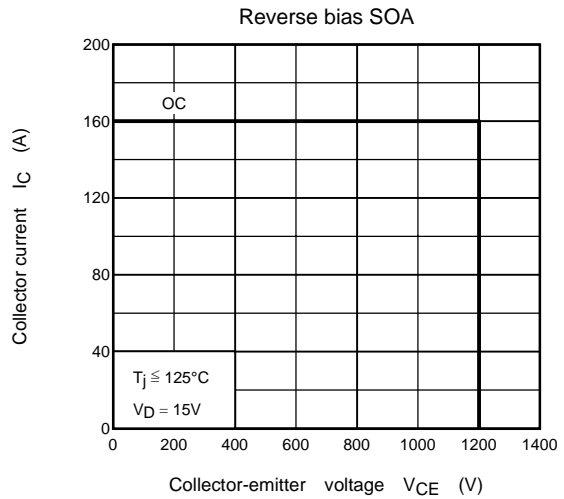
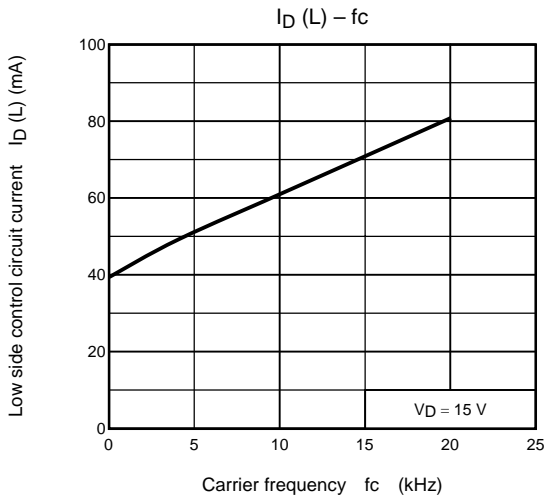
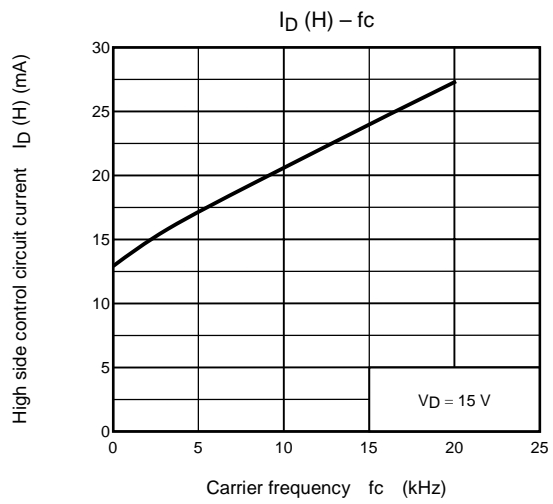
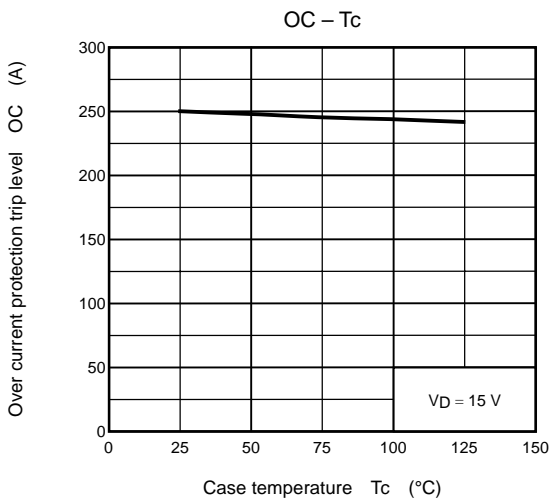

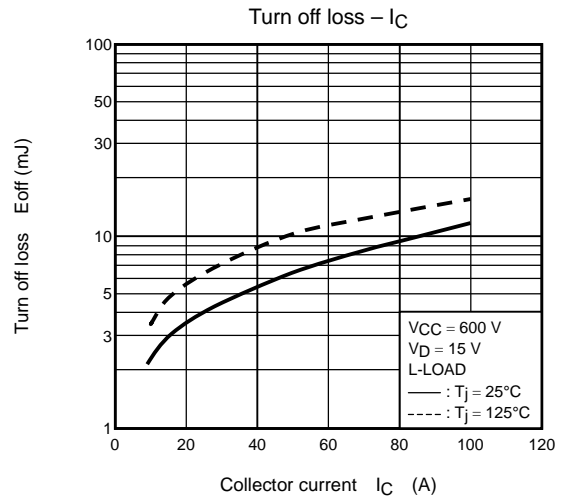
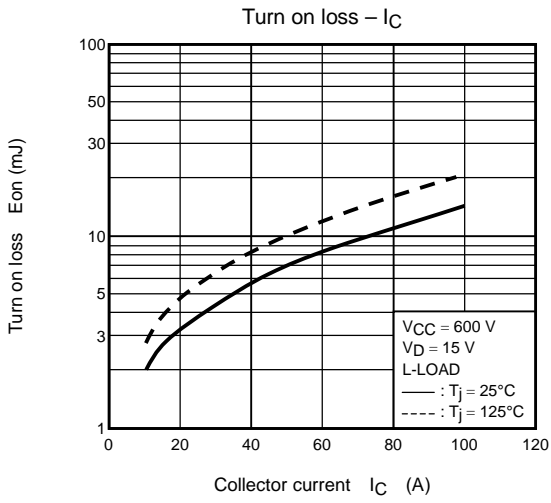

RESTRICTIONS ON PRODUCT USE

000707EAA

- TOSHIBA is continually working to improve the quality and reliability of its products. Nevertheless, semiconductor devices in general can malfunction or fail due to their inherent electrical sensitivity and vulnerability to physical stress. It is the responsibility of the buyer, when utilizing TOSHIBA products, to comply with the standards of safety in making a safe design for the entire system, and to avoid situations in which a malfunction or failure of such TOSHIBA products could cause loss of human life, bodily injury or damage to property.
In developing your designs, please ensure that TOSHIBA products are used within specified operating ranges as set forth in the most recent TOSHIBA products specifications. Also, please keep in mind the precautions and conditions set forth in the "Handling Guide for Semiconductor Devices," or "TOSHIBA Semiconductor Reliability Handbook" etc..
- The TOSHIBA products listed in this document are intended for usage in general electronics applications (computer, personal equipment, office equipment, measuring equipment, industrial robotics, domestic appliances, etc.). These TOSHIBA products are neither intended nor warranted for usage in equipment that requires extraordinarily high quality and/or reliability or a malfunction or failure of which may cause loss of human life or bodily injury ("Unintended Usage"). Unintended Usage include atomic energy control instruments, airplane or spaceship instruments, transportation instruments, traffic signal instruments, combustion control instruments, medical instruments, all types of safety devices, etc.. Unintended Usage of TOSHIBA products listed in this document shall be made at the customer's own risk.
- The information contained herein is presented only as a guide for the applications of our products. No responsibility is assumed by TOSHIBA CORPORATION for any infringements of intellectual property or other rights of the third parties which may result from its use. No license is granted by implication or otherwise under any intellectual property or other rights of TOSHIBA CORPORATION or others.
- The information contained herein is subject to change without notice.

This datasheet has been download from:

www.datasheetcatalog.com

Datasheets for electronics components.